

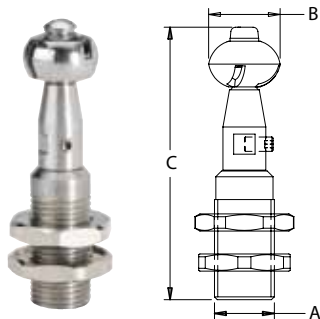



Lavaserbatoi rotante.



Tank rinsing head.



Tête de lavage rotative.

TYPE	FEATURES
 240°	 bar  l/1'
	5 13,5
	7,5 15,5
	10 18



 MAX

Part No.	Angle	A	B mm	C mm	bar	Pack
8185005	240°	G 1/4 M	25	60	10	5
8185003	360°	G 1/4 M	25	60	10	

 MAX

Part No.	Angle	A	B mm	C mm	bar	Pack
8185000	240°	G 1/2 M	25	95	10	5
8185006	360°	G 1/2 M	25	95	10	



 360°	 bar  l/1'
	5 24
	7,5 29
	10 34