

Tank Fittings



Bolted Tank Flanges 164

Threaded Bulk Head Fittings 164

Jet Agitators 165

Anti-Vortex Fittings 165

Fluid Powered Mixers 165

Tank Lids 166 - 168

Basket Filters 167 - 168

Tank Bulk Head Fittings

Bolted Tank Flanges



Part No.	Outlet Thread	Inlet Thread	Code
BF100	1" F	1" F	R
BF150	1 1/2" F	2" F	R
BF200	2" F	2" F	R
BF300	3" NPTF	3" NPTF	R

- Stainless steel fasteners
- EPDM gaskets as standard
- Polypropylene construction

Bottom Drain Flange



Part No.	Outlet Thread	Inlet Thread	Code
BF075BD	3/4" F	1" F	R
BF100BD	1" F	1" F	R
BF150BD	1 1/2" F	2" F	R
BF200BD	2" F	2" F	R
BF300BD	3" NPTF	3" NPTF	R

- Stainless steel fasteners
- EPDM gaskets as standard
- Polypropylene construction

Threaded Bulk Head Fitting - BH Series



Part No.	Thread	Hole	Code
BH12	1/2" F	1 5/8"	R
BH34	3/4" F	1 5/8"	R
BH100	1" F	2 1/16"	R
BH114	1 1/4" F	2 1/2"	R
BH112	1 1/2" F	2 1/2"	R
BH200	2" F	3 1/8"	R
BH300	3" F (NPT)	4 1/4"	R

- EPDM gaskets as standard
- Polypropylene construction

Threaded Bulk Head Fitting - AN Series



Part No.	Thread	Hole	Code
5032AN	3/4" F	1 5/8"	R
5034AN	1" F	1 5/8"	R
5036AN	1 1/4" F	2 7/8"	R
5039AN	1 1/2" F	2 7/8"	R
5042AN	2" F	2 7/8"	R

- EPDM gaskets as standard
- Polypropylene construction

Outlet - Male Thread Only - 805 Series



Part No.	Thread Ø x L	Thread	Code
8050151	14 x 43.5mm	1/2" M	N
8050201	18 x 43.5mm	3/4" M	N
8050251	25 x 50mm	1" M	N
8050301	32 x 40mm	1 1/4" M	N
8050302	32 x 48mm	1 1/4" M	N
8050351	38 x 45mm	1 1/2" M	N
8050401	47 x 64mm	2" M	N

- Polypropylene construction

Complete Outlet - Threaded - 805 Series



Part No.	Thread Ø x L	Thread	Code
8051151	14 x 43.5mm	1/2" M	N
8051201	18 x 43.5mm	3/4" M	N
8051251	25 x 50mm	1" M	N
8051301	32 x 40mm	1 1/4" M	N
8051302	32 x 48mm	1 1/4" M	N
8051351	38 x 45mm	1 1/2" M	N
8051401	47 x 64mm	2" M	N

- Polypropylene construction

Threaded Bulk Head Fitting - TF Series



Part No.	Thread	Hole	Code
TF050	1/2" F	1 5/8"	R
TF075	3/4" F	1 5/8"	R
TF100	1" F	2 1/4"	R
TF125	1 1/4" F	2 1/4"	R
TF150	1 1/2" F	3"	R
TF200	2" F	3"	R
TF300	3" F (NPT)	4 1/2"	R

- EPDM gaskets as standard
- Polypropylene construction

Gaskets for 805 Series - EPDM

Part No.	Fits Thread	Code
G00002008	1/2"	T
G00002010	3/4"	T
G00002012	1"	T
G00002014	1 1/4"	T
G00002016	1 1/2"	T
G00002018	2"	T

Gaskets for TF Series

Part No.	Fits size	Material	Code
150G	1/2" & 3/4"	EPDM	T
200G	1" & 1 1/4"	EPDM	T
300G	1 1/2" & 2"	EPDM	T
150GV	1/2" & 3/4"	Viton	T
200GV	1" & 1 1/4"	Viton	T
300GV	1 1/2" & 2"	Viton	T

EPDM Gaskets for Bolted Flanges

Part No.	Fits size	Material	Code
BF100GE	3/4" 1" 1 1/4"	EPDM	T
BF200GE	1 1/2" & 2"	EPDM	T
BF300GE	3"	EPDM	T

Viton Gaskets for Bolted Flanges

Part No.	Fits size	Material	Code
BF100GV	3/4" 1" 1 1/4"	Viton	T
BF200GV	1 1/2" & 2"	Viton	T
BF300GV	3"	Viton	T

Jet Agitators & Vortex Fittings

Jet Agitators - Straight Inlet

Part No.	Nozz dia	Thread	Code
8201000	1.2mm	1/2" M	N
8201001	1.5mm	1/2" M	N
8201002	2mm	1/2" M	N
8201003	3mm	1/2" M	N

- Polypropylene with ceramic nozzle
- Max flow 240 Lpm - Max press 40 Bar



Jet Agitators - 90° Inlet

Part No.	Nozz dia	Thread	Code
8201004	1.2mm	1/2" M	N
8201005	1.5mm	1/2" M	N
8201006	2mm	1/2" M	N
8201007	3mm	1/2" M	N

- Polypropylene with ceramic nozzle
- Max flow 240 Lpm - Max press 40 Bar



Hypro Jet Agitator

Part No.	Code
3371-0019	R

- Polypropylene construction
- 3/4" Male thread inlet
- Supplied with 3 jet sizes



Hypro Jet Agitator

Part No.	Code
3371	R

- Polypropylene construction
- 1/2" Female thread inlet
- 3/4" Male thread outlet
- Supplied with 3 jet sizes



High Volume Agitator

Part No.	Nozzle	Code
8201010	2mm - ceramic	N
8201011	3mm - ceramic	N
8201012	5mm - S/Steel	N

- Max press 40 Bar
- Max flow 700 Lpm
- Polypropylene construction
- 1/2" Male thread



Anti-Vortex Suction Fitting

Part No.	Barb	Code
8209000	25mm	N
8209001	30mm	N
8209002	35mm	N
8209003	40mm	N
8209004	45mm	N

- Polypropylene construction
- 3/4" M thread
- 2" F backnut



Siphon Tubes

Part No.	Thread	Code
ST200	2" M	R
ST300	3" MNPT	R

- Polypropylene construction



Vent / Anti-Vortex Cap

Part No.	Thread	Description	Code
VC230	2" M	With Screen	R
VC200	2" M	Without Screen	R
VC300	3" MNPT	Without Screen	R

- Can be used as a vent cap or anti-vortex fitting
- Polypropylene - 304 S/Steel screen (optional)



Fluid Powered Mixer - Polypropylene

Part No.	Code
8199000	N

- Polypropylene construction
- Maximum pressure 5 Bar
- 1/2" BSPM inlet
- Elbow connects to the main body via 3/4" BSPM thread



Fluid Powered Mixer - Stainless Steel

Part No.	Code
8199001	N

- Stainless steel & brass construction
- Maximum pressure 5 Bar
- 1/2" BSPM inlet
- 1/2" BSPM bulk head fitting with nuts



Tank Lids & Basket Filters

All Geoline basket filters, tank lids and accessories are designed to meet a variety of requirements and specifications for transportation of liquids in agricultural and industrial applications. They are manufactured in Polypropylene, with EPDM gaskets (Viton on demand) and AISI 304 stainless steel parts.

100 Series Tank Lids & Accessories



Threaded - o-ring not included		
Part No.	Description	Code
8178002	No vent	N
8367000	Replacement vent	N

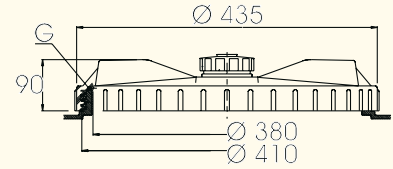

Threaded - o-ring not included					
Part No.	Description	A	B	C	Code
8178000	No vent	172 mm	6"	56 mm	N
8178001	1 NRV with spring	172 mm	6"	56 mm	N
G00001066	Replacement o-ring				T

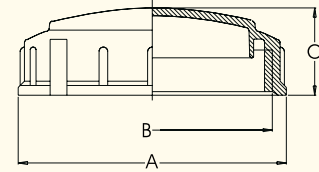

Threaded - o-ring not included					
Part No.	Description	A mm	B mm	C mm	Code
8178004	No vent	240	226	55	N
8178005	EPDM Valve	240	226	55	N
8178006	1 NRV with spring	240	226	55	N
G00001075	o-ring for all above lids				T

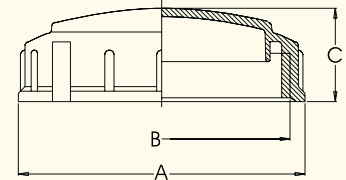

Rubber lids with suction valve			
Part No.	A mm	B mm	Code
8184000	265	20	N
8184001	365	20	N
8184002	454	22	N

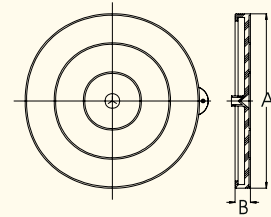

140 Series Tank Lids & Accessories



Manta 140 series - threaded						
Part No.	Description	A mm	B mm	C mm	D mm	Code
8140000	No vent	140	120	8	n/a	N
8140001	2 NRV with springs	140	120	8	52.5	N
8140002	2 vents	140	120	8	52.5	N
8140003	4 vents	140	120	8	52.5	N

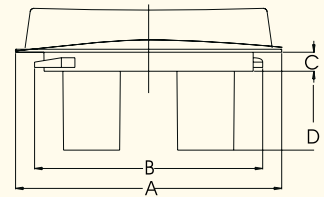

Tank lid ring for Manta 140 series						
Part No.	Description	A mm	B mm	C mm	L mm	Code
8142000	No o-ring	154	125	112	17	N
G00000000	o-ring for above ring					T

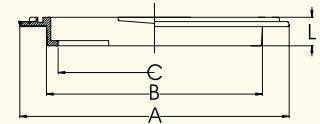

255 Series Tank Lids & Accessories



Manta 255 series - threaded				
Part No.	Description	A mm	B mm	Code
8146000	No valve	250	210	N
8146001	Non return valve	250	210	N
8146002	Vented	250	210	N

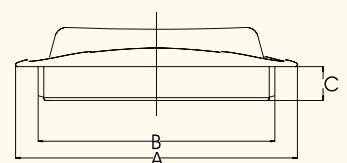

Tank Lids & Basket Filters

255 Series Tank Lids & Accessories

Tank lid rings for 255 Manta series							
Part No.	Description	A mm	B mm	C mm	L mm	D mm	Code
8148000	Plain hole	262	217	192	39	n/a	N
8148001	Plain hole with lip	262	217	192	39	230	N
8148002	Fitted with o-ring	265	217	192	39	n/a	N
G00000001	Replacement o-ring for 8148002						T

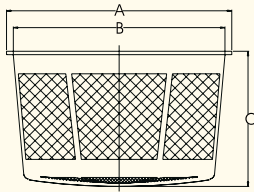
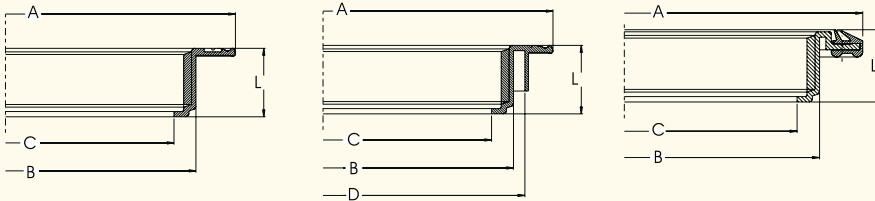

Basket filters for 255 Manta series					
Part No.	Description	A mm	B mm	C mm	Code
8147000	Suitable for all Manta 255 series	201	189	50	N
8147001		201	189	120	N
8147002		201	189	240	N



355 Series Tank Lids & Accessories

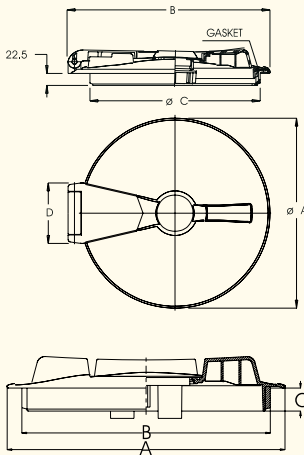

Abat 355 series - hinged with integrated tank ring & lid o-ring							
Part No.	Description	A mm	B mm	C mm	D mm	Code	
8169004	With vent	357	381	320	114	N	
8170004	With vent	457	480	415	125	N	
G00000006	Replacement o-ring for all lids						T



Manta 355 series - threaded					
Part No.	Description	A mm	B mm	C mm	Code
8152000	No vent	350	313	29	N
8152001	2 NRV with springs	350	313	29	N
8152002	2 vents	350	313	29	N
8152003	4 vents	350	313	29	N
8152004	1 vent	350	313	29	N
8152005	PVC NRV	350	313	29	N



Tank rings for Manta 355 series							
Part No.	Description	A mm	B mm	C mm	L mm	D mm	Code
8154000	Plain hole	357	320	290	38	n/a	N
8154001	Plain hole with lip	357	320	290	38	335	N
8154002	Fitted with o-ring	368	320	290	38	n/a	N
G00000002	Replacement o-ring for 8154002						T

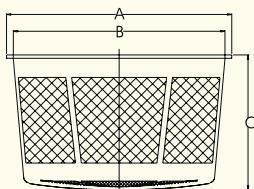
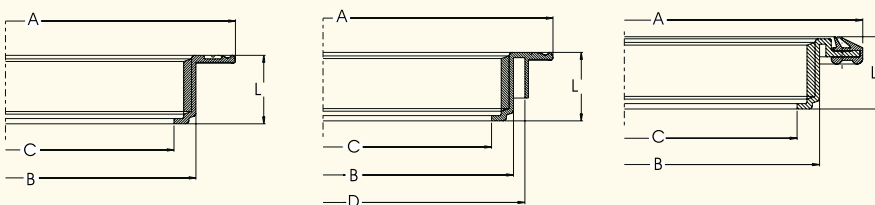

Basket filters for 355 series lids					
Part No.	Description	A mm	B mm	C mm	Code
8153000	Suitable for all	301	287	60	N
8153001	Manta 355 series	301	287	240	N



Tank Lids & Basket Filters

455 Series Tank Lids & Accessories



Manta 455 series - threaded lids					
Part No.	Description	A mm	B mm	C mm	Code
8158000	No vent	450	408	23	N
8158001	2 rubber NRV	450	408	23	N
8158002	2 vents	450	408	23	N
8158003	4 vents	450	408	23	N
8158004	PVC NRV	450	408	23	N
8158005	1 vent	450	408	23	N

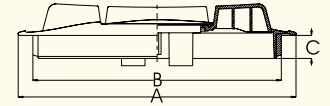

Tank rings for Manta 455 series							
Part No.	Description	A mm	B mm	C mm	L mm	D mm	Code
8160000	Plain hole	457	415	382	35	n/a	N
8160001	Plain hole with lip	457	415	382	35	430	N
8160002	Fitted with o-ring	463	415	380	35	n/a	N
G00000003	Replacement o-ring for 8160002						T

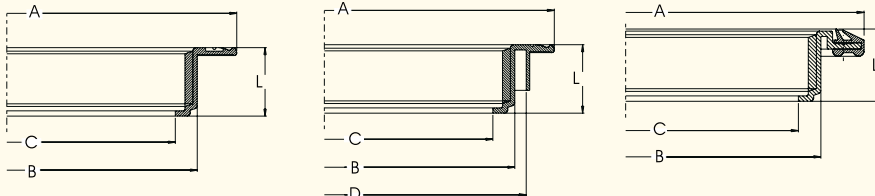

Basket filters for 455 series lids					
Part No.	Description	A mm	B mm	C mm	Code
8159000	Polypropylene	400	380	180	N
8159001		400	380	280	N
8159002		400	380	320	N

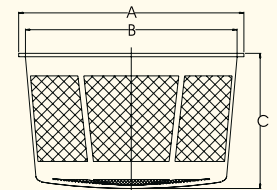

EPDM Air Valve



Part No.	Description	Code
V00101000	Fits all lids with rubber valves	T

- 33 mm Ø